

Valena™ Life - Valena™ INMATIC
Cat. 6 RJ45 sockets

Cat. Nos: 7 530 42/43/46/47 - 7 531 42/43/46/47
7 532 42/43/46/47 - 7 533 42/43/46/47 - 7 563 42/43/46/47

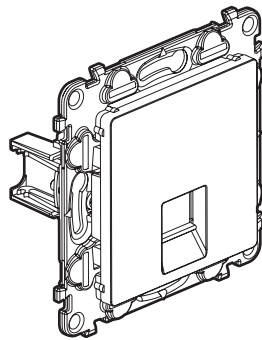

7 531 42

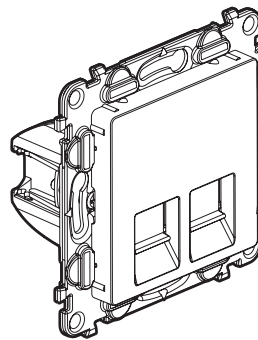

7 531 43

1. USE

Category 6 RJ45 socket.
 Allows high-speed transmissions (Gigabit Ethernet).
 Can be flush mounted in a box min. 40 mm deep.
 To be equipped with plate.

2. RANGE

Designation	Mechanism + cover plate				Mechanism only
	White	Ivory	Aluminium	Black	
UTP Cat. 6 RJ45 - with claws	7 531 42	7 532 42	7 533 42	7 563 42	7 530 42
STP Cat. 6 RJ45 - with claws	7 531 46	7 532 46	7 533 46	7 563 46	7 530 46
Double UTP Cat. 6 RJ45 - with claws	7 531 43	7 532 43	7 533 43	7 563 43	7 530 43
Double STP Cat. 6 RJ45 - with claws	7 531 47	7 532 47	7 533 47	7 563 47	7 530 47

3. PRESENTATION

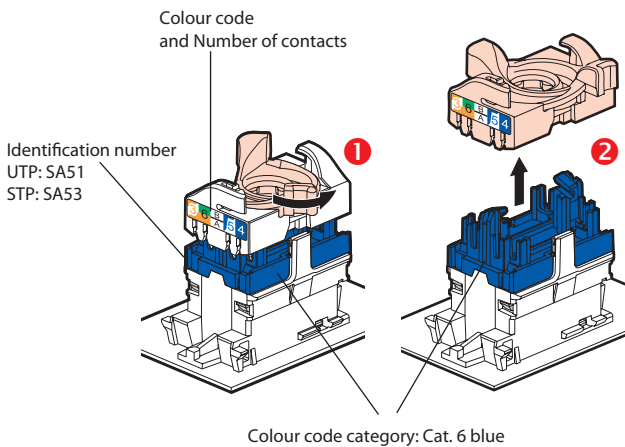

4. DIMENSIONS (mm)

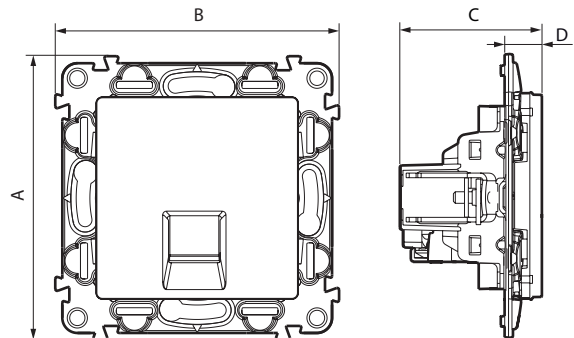

Cat. Nos	A	B	C	D
7 531 42/46 - 7 532 42/46 - 7 533 42/46 - 7 563 42/46	75	75	37	10
7 531 43/47 - 7 532 43/47 - 7 533 43/47 - 7 563 43/47	75	75	35	8

5. STANDARD RJ45 CONNECTION

Accepts the following cable connectors:
RJ 11 (4 contacts), RJ 12 (6 contacts), RJ 45 (9 contacts).

Double colour code T568A and T568B on terminals:

UTP 8 contacts

FTP 9 contacts

STP 9 contacts 360° screen

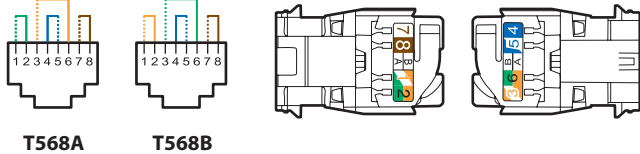

Conductors supported:

- Single core/Multicore: 0.4 to 0.65 mm, AWG 26 to 22

- Polyethylene conductor insulation: Ø on insulation 0.85 to 1.7 mm

RJ45 connectors are equipped with a locking nut. They do not require a special tool and can be re-wired if a mistake is made.

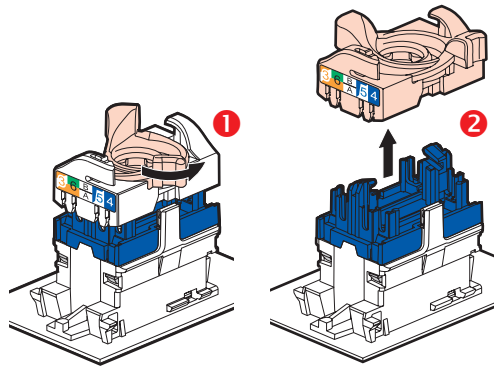

This system makes it easy to spread pairs before fitting them onto the connector.

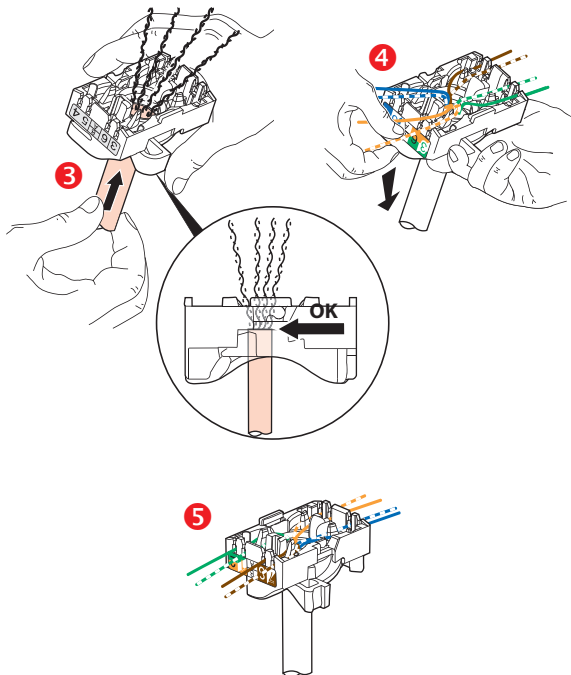

Spreading the cables ensures that a pair-breakage distance of 13 mm is kept between each pair.

Spreading pairs at 90° to the cable ensures the best possible performance.

6. TECHNICAL CHARACTERISTICS

■ 6.1 Mechanical characteristics

Protection against impacts: IK 03

Protection against solid/bodies and liquids: IP 20

Maximum number of connections and disconnections: 5 without replacing the wire.

Endurance: 2500 operations (plugging in/unplugging).

■ 6.2 Material characteristics

• Cover plate: White ABS RAL 9003

Ivory ABS RAL 1013

Painted ABS Aluminium and Black

Halogen-free

UV-resistant

• Motor: Contacts: gold/nickel, thickness of gold > 0.8 µm minimum

Metal parts: bronze, nickel, platinum, gold

Polycarbonate PBT

• Support : Polycarbonate grey RAL 7037 + metal

Halogen-free

Self-extinguishing:

850°C/30 s for insulating components holding live parts in place

650°C/30 s for other insulating components

■ 6.3 Electrical characteristics

Breakdown voltage 1000 VDC

Contact resistance 20 mΩ

Insulation resistance 500 mΩ at 100 VDC

Tested and independently certified to comply with IEC 60512-99-001 and IEC 60512-99-002 for PoE support up to 90 W (Type 4).

■ 6.4 Climate characteristics

Storage temperature: - 10°C to + 70°C

Usage temperature: - 5°C to + 35°C

7. CARE

Clean the surface with a cloth.

Do not use acetone, tar-removing cleaning agents or trichloroethylene.

Resistant to the following products: Hexane (EN 60669-1), methylated spirit, soapy water, diluted ammonia, bleach diluted to 10%, window-cleaning products, pre-impregnated wipes.

Caution: Always test before using special cleaning products.

8. STANDARDS AND APPROVALS

Connectors are compliant to requirements for the following remote powering applications:

IEEE 802.3af, IEEE 802.3at, IEEE 802.3bt : "Power over Ethernet", Type 1 to 4, up to 90 W.

Compliant with installation and manufacturing standards.

See e-catalogue.

9. PERFORMANCE

■ **9.1 Performance of components (RJ 45 connectors)**

Return loss

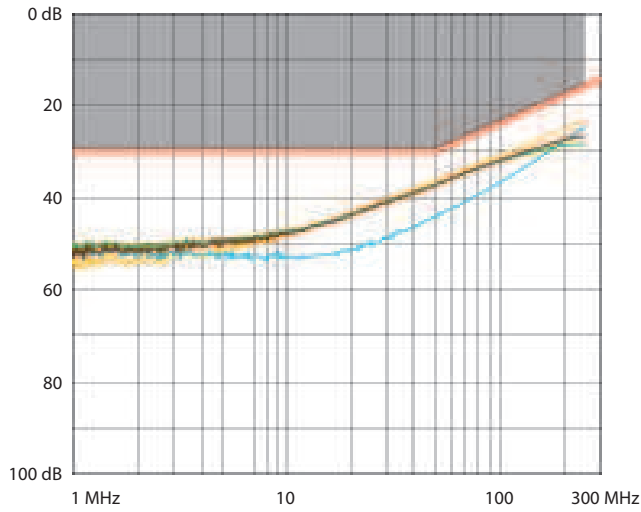

Attenuation

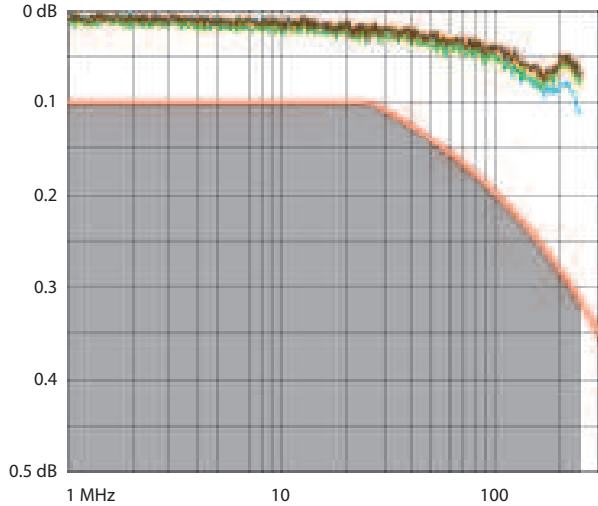

NEXT (Near end Crosstalk Attenuation)

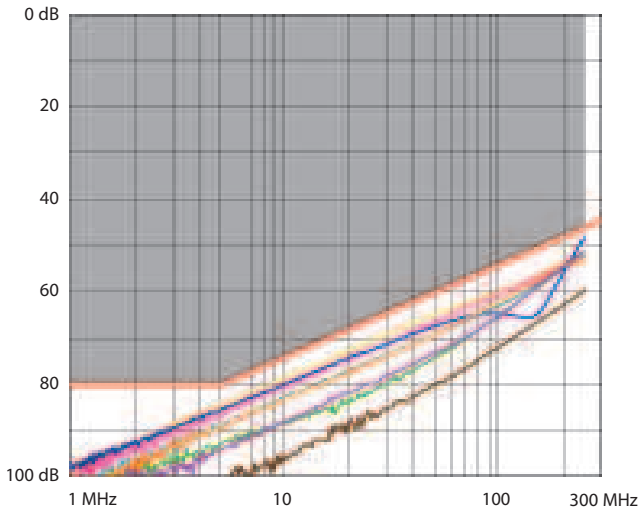

9. PERFORMANCE (continued)

■ **9.1 Performance of components (RJ 45 connectors)**

FEXT (Far end Crosstalk Attenuation)

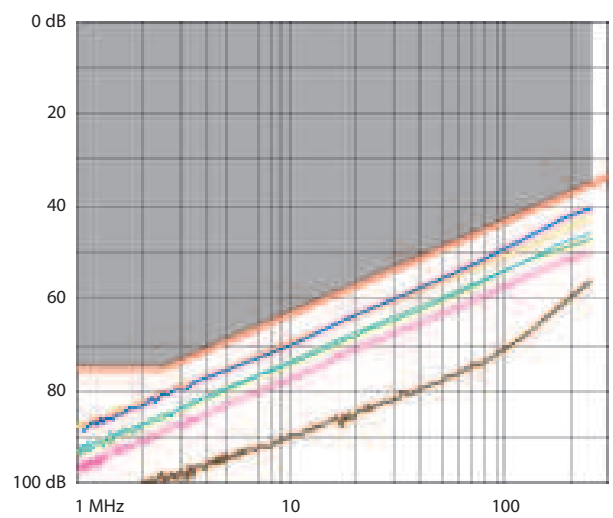

■ **9.2 Performance of permanent link with F/UTP cable**

Return loss

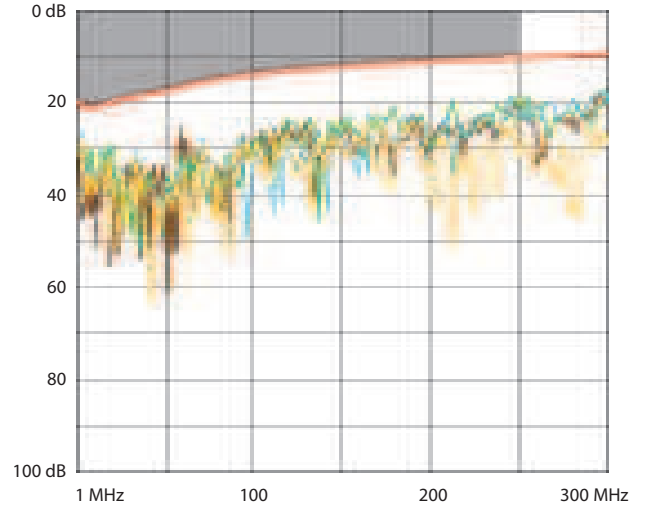

Attenuation

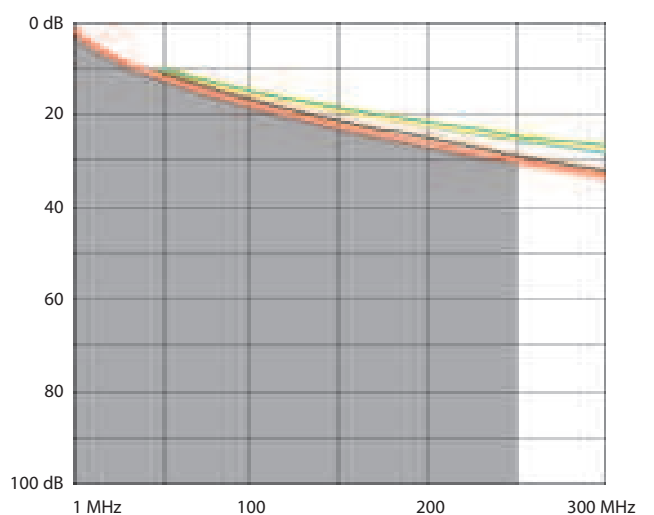

9. PERFORMANCE (continued)

■ 9.2 Performance of permanent link with F/UTP cable
 NEXT (Near end Crosstalk Attenuation)

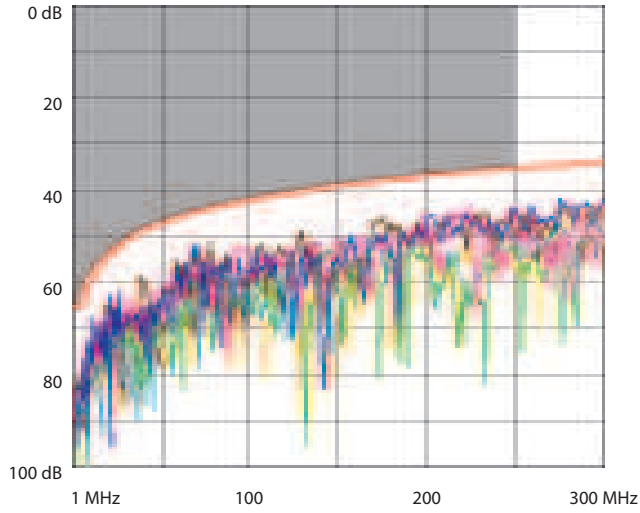

PS NEXT (Power Sum NEXT)

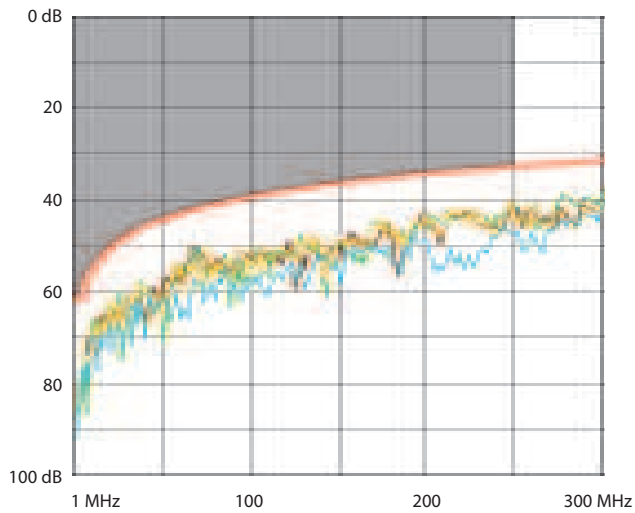

ACR (Attenuation to crosstalk ratio)

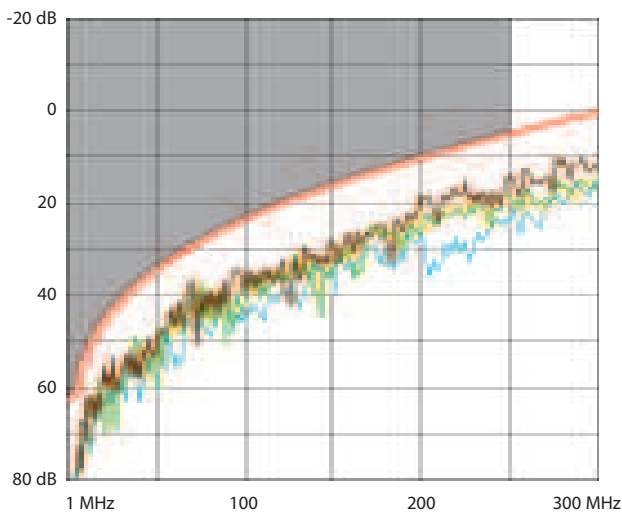

9. PERFORMANCE (continued)

■ 9.2 Performance of permanent link with F/UTP cable (continued)
 ELFEXT (Equal Level End Crosstalk Attenuation)

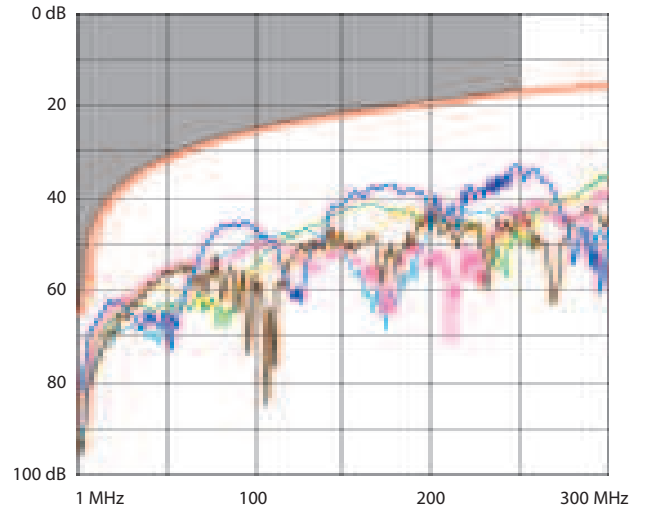

Delay skew

